



CS6P

All-Black

250 | 255 | 260M Non-Domestic

PRODUCT | KEY FEATURES

- 

Excellent Module Efficiency
Up to 16.16%
- 

High Performance at Low Irradiance Above 95.5%
- 

Positive Power Tolerance
Up to 5W
- 

High PTC Rating
Up to 91.25%
- 

Anti-Soil Buildup, Anti-Reflective
Module Surface
- 

IP67 Junction Box
Long-Term Weather Endurance
- 

Heavy snow Load
Up to 5400Pa
- 

Salt Mist, Ammonia and Blowing Sand
Resistance, Apply to Seaside, Farm and
Desert Environment

PRODUCT | WARRANTY & INSURANCE

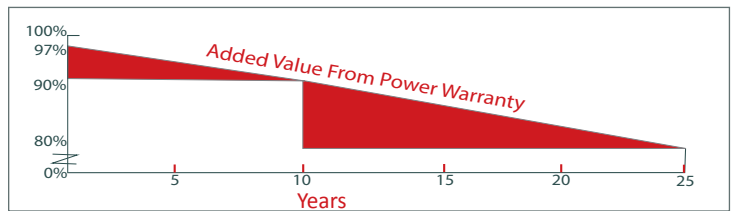

25 Year Industry leading linear power output warranty
10 Year Product warranty on materials and workmanship



Canadian Solar provides 100% non-cancellable, and immediate warranty insurance.

PRODUCT & MANAGEMENT SYSTEM | CERTIFICATES

IEC61215/IEC61730: VDE/TUV/CE/MCS/CEC AU/INMETRO
CEC listed (US)/FSEC (US Florida)

UL1703: CSA

PV CYCLE | IEC61701 ED2: VDE | UL Fire Class Rating: C

- ISO9001:2008 | Quality management system
- ISOTS16949:2009 | The automotive industry quality management system
- ISO14001:2004 | Standards for environmental management system
- QC080000:2012 | The certificate for hazardous substances process management
- OHSAS 18001:2007 | International standards for occupational health and safety

Canadian Solar Inc.

Founded in 2001 in Canada, Canadian Solar Inc., (NASDAQ:CSIQ) is one of the world's largest and foremost solar power companies. As a leading manufacturer of solar modules and PV project developer with about 6 GW of premium quality modules deployed around the world more than a decade, Canadian Solar is one of the most bankable solar companies in the world. Canadian Solar operates in six continents with customers in over 70 countries. Canadian Solar is committed to providing high-quality solar products, solar system solutions and services to customers around the world.



888-777-5255
sales@eSolar.ca

ELECTRICAL DATA | STC

Electrical Data	CS6P-250M	CS6P-255M	CS6P-260M
Nominal Maximum Power (Pmax)	250W	255W	260W
Optimum Operating Voltage (Vmp)	30.4V	30.5V	30.7V
Optimum Operating Current (Imp)	8.22A	8.35A	8.48A
Open Circuit Voltage (Voc)	37.5V	37.7V	37.8V
Short Circuit Current (Isc)	8.74A	8.87A	8.99A
Module Efficiency	15.54%	15.85%	16.16%
Operating Temperature	-40°C~+85°C		
Maximum System Voltage	1000V (IEC)/600V (UL)		
Maximum Series Fuse Rating	15A		
UL Fire Classification	Class C		
Power Tolerance	0~+5W		

*Under standard test conditions (STC) of irradiance of 1000W/m², spectrum AM 1.5 and cell temperature of 25°C

ELECTRICAL DATA | NOCT

Electrical Data	CS6P-250M	CS6P-255M	CS6P-260M
Nominal Maximum Power (Pmax)	180W	184W	188W
Optimum Operating Voltage (Vmp)	27.7V	27.8V	28.0V
Optimum Operating Current (Imp)	6.51A	6.62A	6.70A
Open Circuit Voltage (Voc)	34.4V	34.6V	34.7V
Short Circuit Current (Isc)	7.08A	7.18A	7.28A

*Under nominal operating temperature, irradiance of 800 W/m², spectrum AM 1.5, ambient temperature 20°C wind speed 1 m/s.

PRODUCT | MECHANICAL DATA

Specification	Data
Cell Type:	Mono-crystalline 156 x 156mm.
Cell Arrangement:	60 (6 x 10)
Dimensions:	1638 x 982 x 40mm (64.5 x 38.7 x 1.57in)
Weight:	18.5kg (40.8 lbs.)
Front Cover:	3.2mm tempered glass
Module Frame Material:	Anodized aluminum alloy
J-Box:	IP65 or IP67, 3 diodes
Cable:	4mm ² (IEC)/12AWG (UL)/1000mm
Connectors:	MC4 or MC4 Comparable
Standard Packaging:	24 pcs, 504kg (Quantity and weight per pallet)
Module Pieces per Container:	672 pcs (40' HQ)

TEMPERATURE | CHARACTERISTICS

Specification	Data
Temperature Coefficient (Pmax)	-0.45%/°C
Temperature Coefficient (Voc)	-0.35%/°C
Temperature Coefficient (Isc)	0.060%/°C
Normal Operating Cell Temperature	45±2°C

PERFORMANCE | AT LOW IRRADIANCE

Industry leading performance at low irradiation environments, +95.5% PV module efficiency from an irradiance of 1000w/m² to 200w/m² (AM 1.5, 25°C).

*We, Canadian Solar Inc., hereby disclaim any representation, warranty or guarantee that the information provided in this datasheet is accurate, correct, reliable or current. No party may claim reliance on any information furnished herein. Specifications, pictures, drawings, product features and certifications described in this datasheet are for reference purposes only. We reserve the right to make any adjustments to the information contained herein at any time without notice. Please always obtain the most recent revision of datasheet which shall be duly signed by the authorized representatives of both parties and incorporated into the binding contract made by the parties governing all transaction related to the purchase and sale of the products described herein.

MODULE | ENGINEERING DRAWING

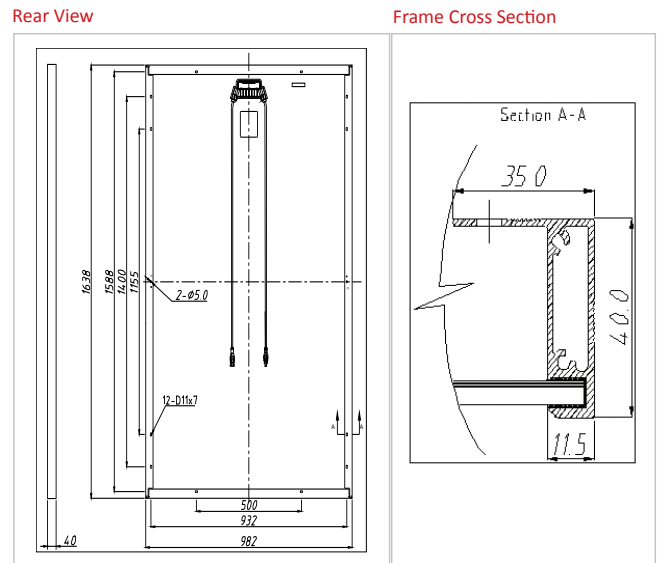

CS6P-260M | I-V CURVES

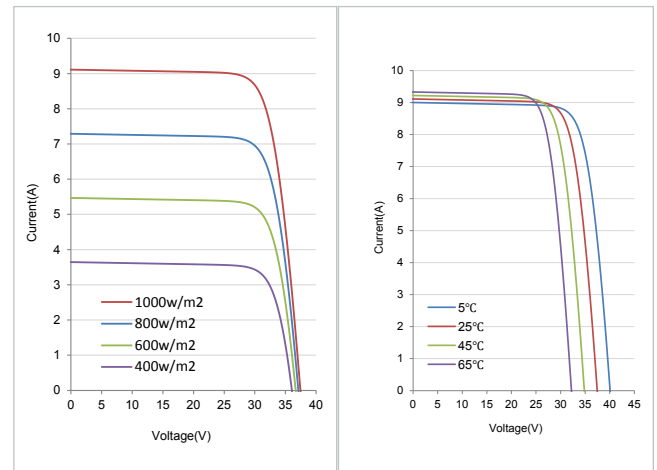

Partner Section

